

## Serpentine Solar Water Heating



Guidelines for Fabrication

**Revision**  
B – FinalDraft

**Date**  
November 2009

**Author**  
Ben Dana

### **Notes and Glossary:**

*All measurements in the text are in mm unless otherwise shown.*

*Measurements describing the positions of holes for bolts or inlet pipes etc are taken to the centre of the hole unless other-wise stated.*

*Xela – Quetzaltenango*

*AIDG – Appropriate Infrastructure Development Group.*

*Xelateco – A renewable energy manufacture/ installation business set up by AIDG Guatemala*

*Azimuth: orientation from due South 0°.*

*SSWH – Serpentine Solar Water Heating*

*SWH – Solar Water Heating*

*HG “Hierro Galvanizado”: Galvanized Pipe*

*MDF Medium Density Fibreboard*

*NPT: National Pipe Threading. American pipe gauge standards:*

[http://www.engineeringtoolbox.com/npt-national-pipe-taper-threads-d\\_750.html](http://www.engineeringtoolbox.com/npt-national-pipe-taper-threads-d_750.html)

*°C – degrees centigrades*

### **References**

B. Deus et al (2004): **ZigZag Collector**, BABICO and WOT Publications

B. Dana (2009): **Design Manual, DIY Serpentine Solar Water Heating**, AIDG

1 Abstract.....	4
2. Solar Collector Fabrication.....	5
2.1 The Heat Exchanger.....	5
2.1.1 <i>Serpentine Bending</i> .....	5
2.1.2 <i>Joining the serpentine to the absorber plate with wire</i> .....	10
2.2 The Frame.....	11
2.2.1 <i>Side Sections</i> .....	11
2.2.2 <i>Frame Backing Plate</i> .....	13
2.2.3 <i>Frame Assembly</i> .....	13
2.2.4 <i>Top of the frame</i> .....	13
2.2.5 <i>Enclosing the Absorber in the Frame</i> .....	13
2.3 Mounting Brackets/ Clamps: Fabrication .....	14
2.4 Mounting the Collector Cover and sealing.....	18
3 Fabricating the Hot Water Tank.....	19
3.1 Hot Water Tank Design.....	19
3.1.1 <i>Insulation</i> .....	19
3.1.6 <i>Weather proofing</i> .....	21
3.2 Hot Water Tank Fabrication .....	21
3.2.1 <i>Making the holes in the inner and outer tanks</i> .....	21
3.2.2 <i>Assembling the Inlets</i> .....	22
3.2.3 <i>Creating the rubber washers</i> .....	22
4 Installation.....	23
4.1 Selecting the Site .....	23
4.1.4 <i>Position of the Solar Installation relative to the shower</i> .....	23
4.2 Pipe-work .....	24
4.2.1 <i>CPVC</i> .....	24
4.2.2 <i>Copper: Protection against high-temperatures</i> .....	24
4.2.3 <i>Pipe-work installation for thermo-siphon</i> .....	24
4.2.4 <i>Pipe Lagging</i> .....	25
4.3 <i>System Charging: procedure for air-venting</i> .....	25
4.4 <i>Thermal Mixing at the Shower</i> .....	25
4.5 <i>Mounting Systems</i> .....	26
5. Material Costs in Guatemala.....	28
Appendix 1 Constructing the Pipe Bending Set .....	29
Appendix 2: Alternative Bending Set with dimensions .....	35

# 1 Abstract

The Serpentine is a solar thermal collector developed as part of a low cost water heating system by the AIDG for households in Xela, Guatemala. This document gives a comprehensive list of system component materials, together with detailed accounts of solar collector and hot water tank fabrication, and basic installation guidance. It should be read together with *Design Manual: DIY Serpentine Solar Water Heating*. This second document outlines general design principles; evaluates other designs; provides system sizing guidance, and recommends modifications for future research.

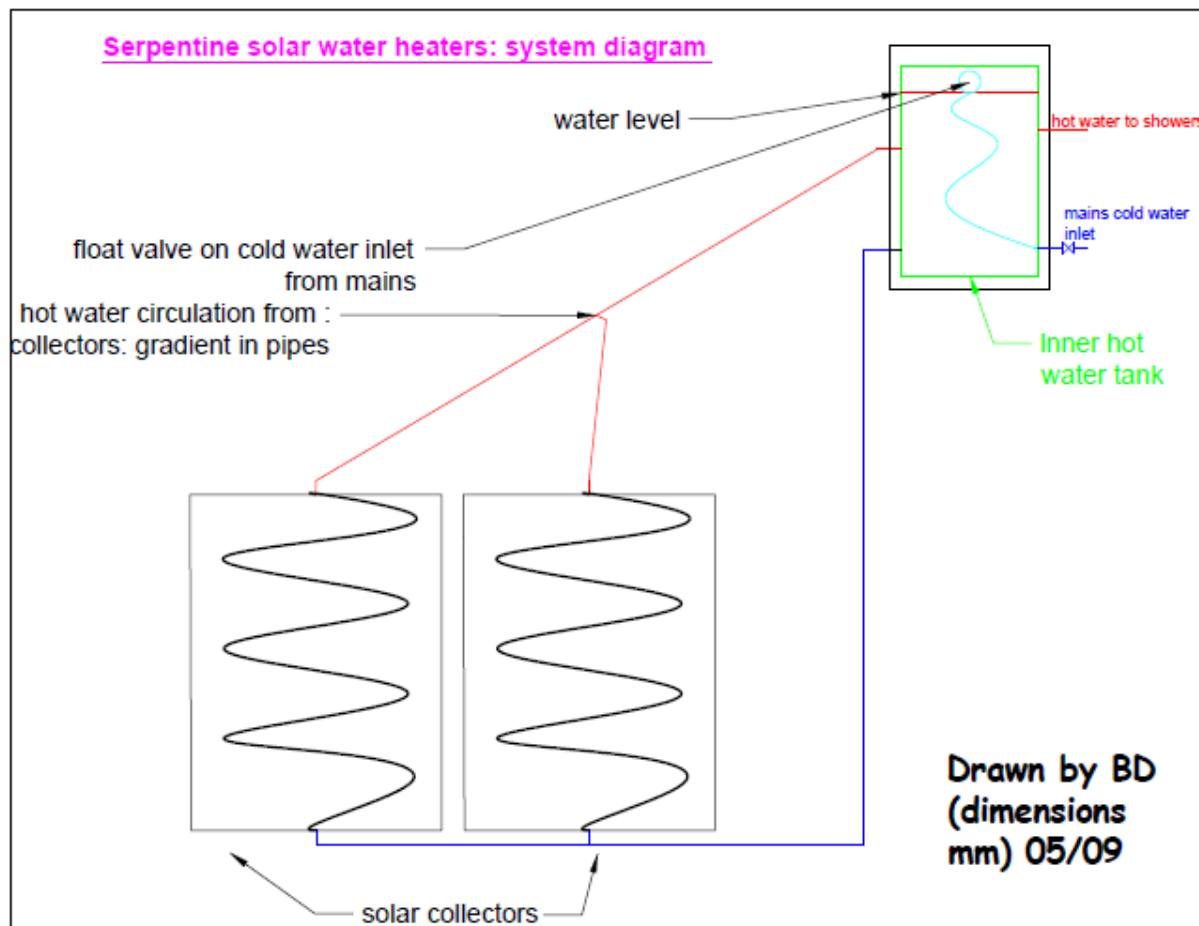

## 2. Solar Collector Fabrication

### 2.1 The Heat Exchanger

(Reprinted from B. Deus et al (2004): *ZigZag Collector*, BABICO and WOT Publications)



#### 2.1.1 Serpentine Bending

The pipe must be shaped into 7 bends and 2 nearly perpendicular ends. A pipe bending set should be made for the purpose: guidance is given in Appendix 1. Standard bending springs used by electricians or central heating engineers are reported to be unable to produce a tight enough bend radius.

The following **tools** are needed to prepare the pipes:

- A pipe-holding clamp; a pipe-cutter or hacksaw; a thread-cutter; a folding ruler or measuring rod; a marker (felt pen)

For 1 hot water system 3 absorbers are needed. So we start to prepare 3 pipes at once. Put the pipes parallel to one side against a wall. Take the shortest pipe as standard and mark all pipes at the same length. Cut the pipes straight at the indicated length by means of a pipe-cutter or hacksaw. On the shortened ends we make a half-inch thread by means of a thread-cutter. Check the screw thread of all pipes at both sides by means of a half-inch socket. If the socket can be screwed on by hand, it's ok. Keep the socket on to protect the thread while bending the pipe. Mark the middle of each pipe (around the entire pipe.)

#### Starting the pipe bending

Slip a ½" pipe into the set. The pipe is locked between disk G and block H (see Appendix 1).

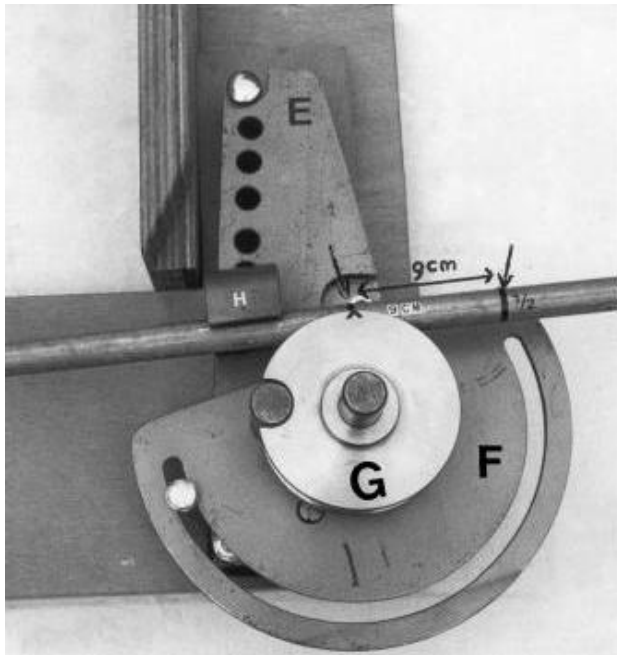

*Mark a second point at 9 cm left to the indicated middle of the pipe. The second market point must correspond with the mark on the disk. Here the first bend will begin.*



*To start bending we use a bending-claw **m** with accessory cylinder **K** plus half-shaft. Put cylinder **K** half-shaft into the third hole of bending-claw **m**.*

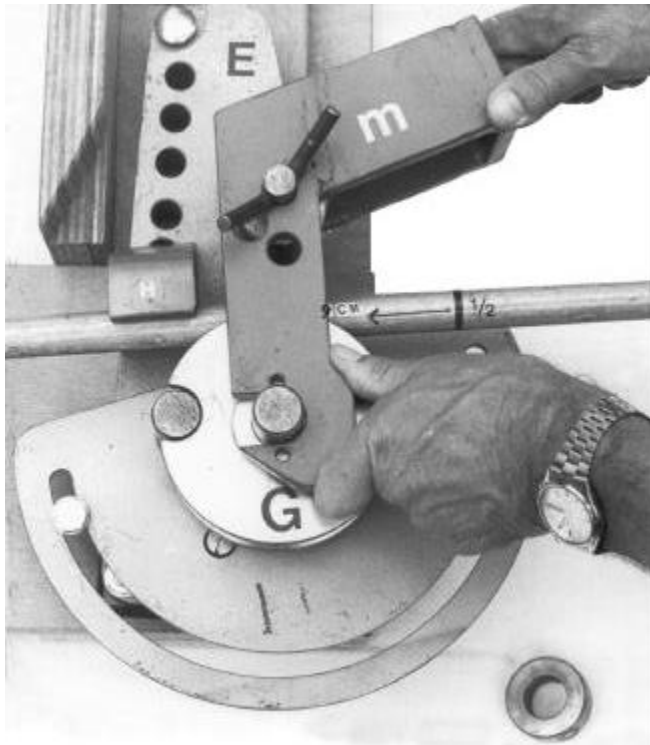

*Slip the bending-claw **m** over the spindle. (disk **G** and pipe are in between the claw)*



*Fix ring **O** over the spindle and lock it up with the 2 doweled joints.*

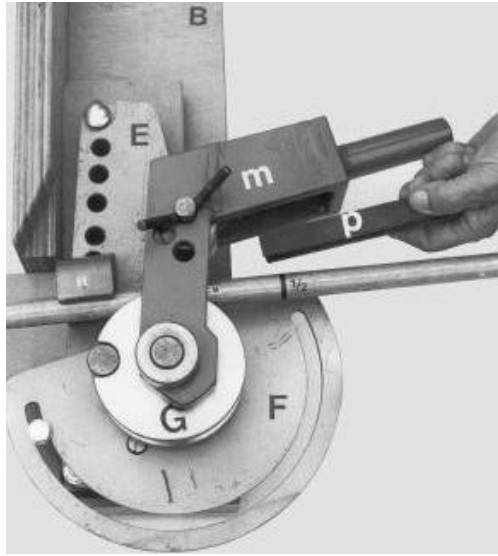
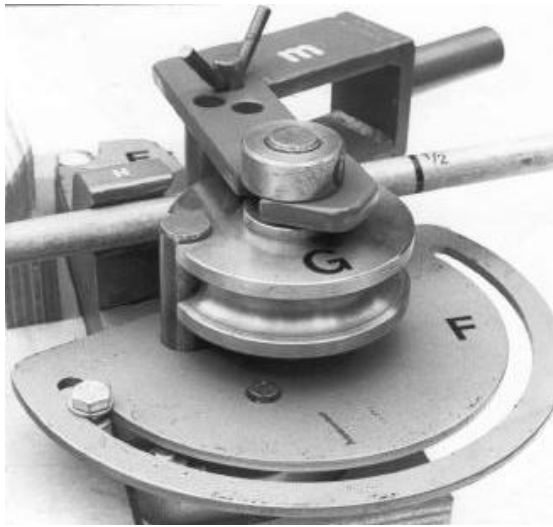

*Press pipe-guide P between pipe and cylinder K.*

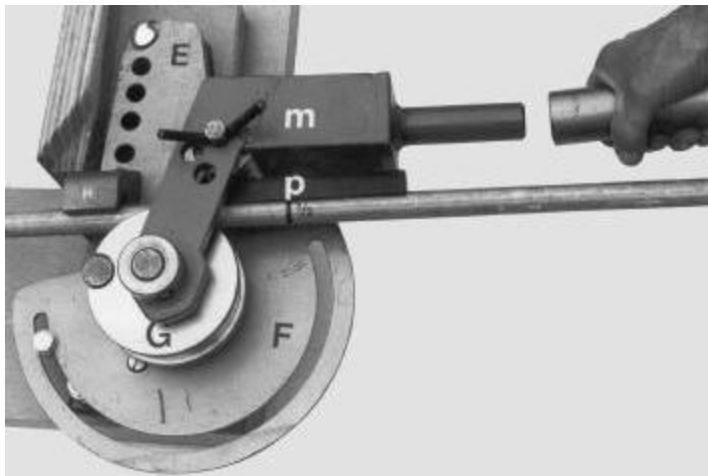

*Slip the lever over the handle of bending-claw m and pull the lever towards you.*

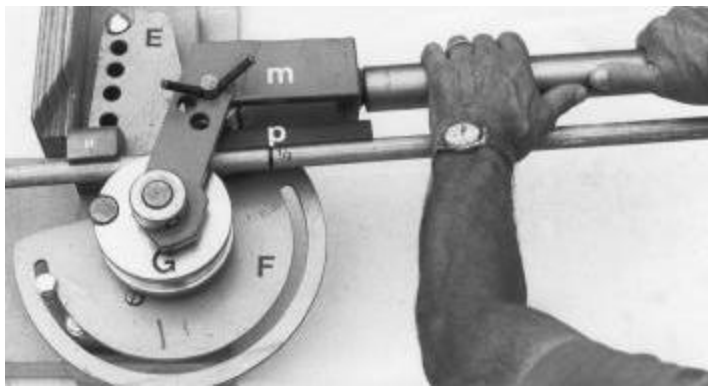

*Pipe and lever are now in parallel position.  
WARNING: Be sure that the second mark on the pipe is still corresponding with the mark on the disk G.*

### The pipe bending procedure

To bend correctly use the following instructions:

- Bend gradually without forcing the set.
- About halfway the bend pipe-guide **P** must be moved forward.
- Press the lever until the bending-claw runs up against the adjusting-nut in the groove of bending plate **F**.

If the radius of the bend looks too wide, the adjusting nut should be moved. The horizontal pieces of the pipe should be slightly inclined upwards to avoid airlocks.

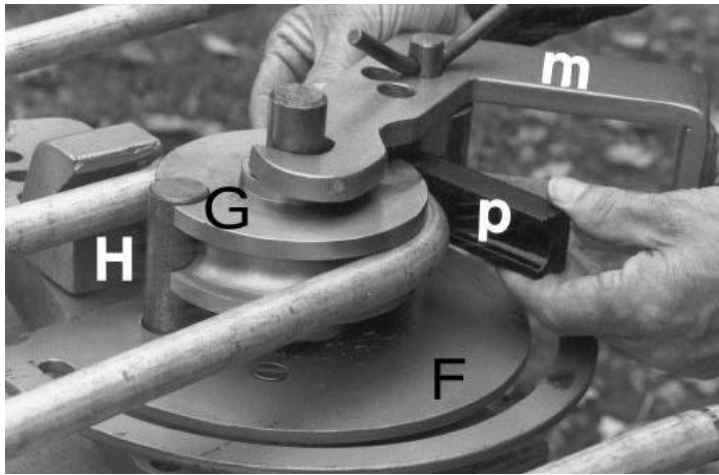

*Moving the pipe-guide **P**.*

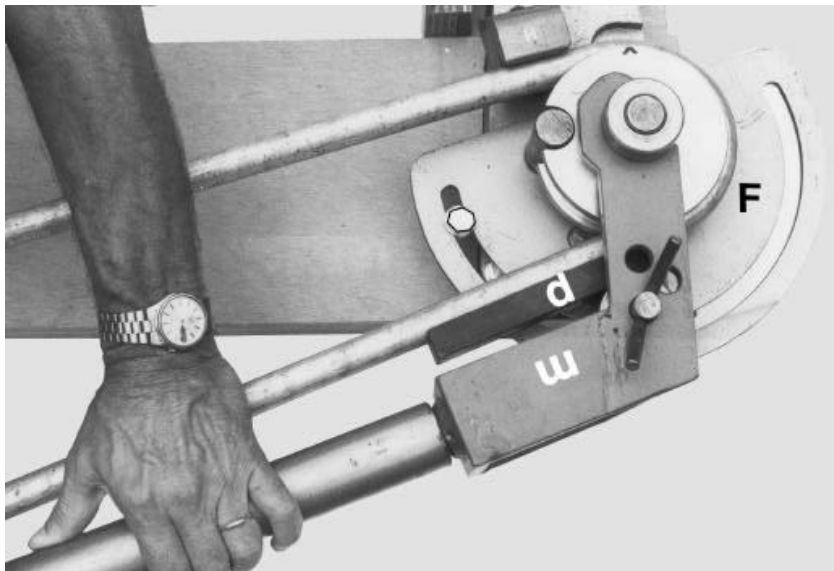

*The adjusting nut is in the **F** plate, to the left of the pulley. Use this nut to set the correct (maximum) bending angle of the pipe.*

After the first bend is completed put a mark at 56 cm distance from the beginning of the first bend. Here we will start the second bend.

For all the next bends the same manner is used. The pictures on the next page indicate the bending procedure while making the 7 bends.



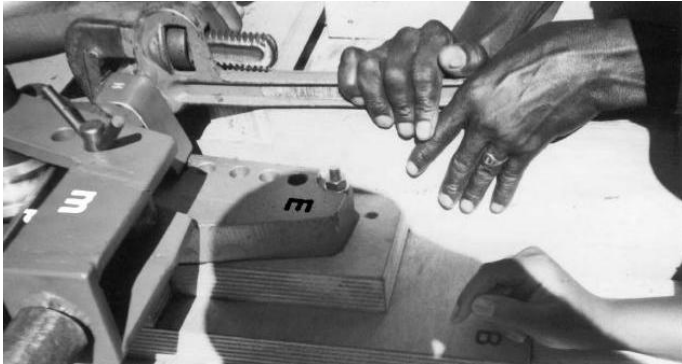

*Use a pipe wrench to stop the pipe slipping ( in front of block **H**.)*

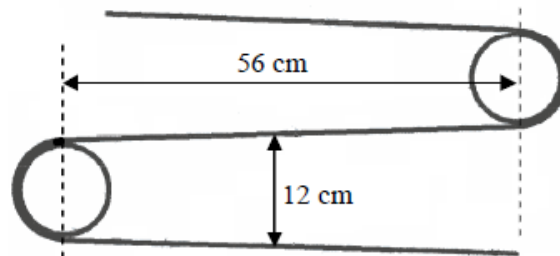

*After bending the pipe, it will spring back. To keep the right angle in between the bends, you have to measure 12 cm. (in the middle)*

Here you see two collectors:

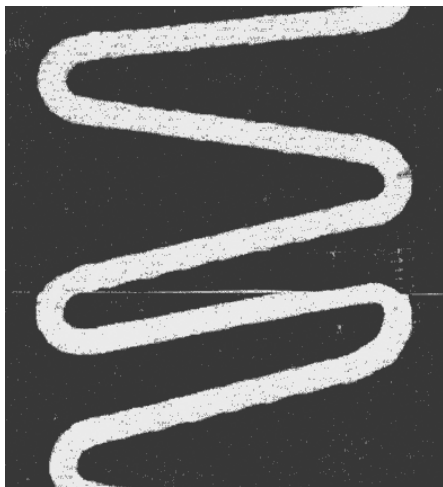

*The second bend of this collector is pointed down. Air bubbles will not pass it. So the circulation will be blocked.*

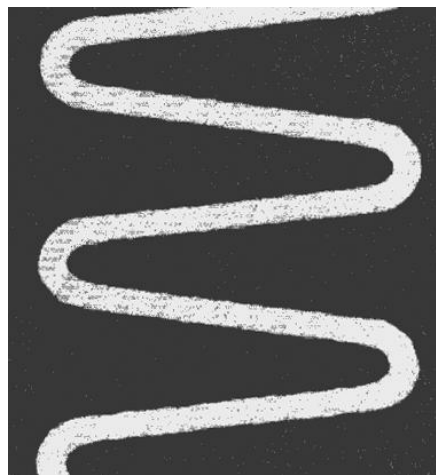

*This collector is well bent because all bends are sloping upwards. So the hot water circulation continues without any problem*

The first bend is 20cm along the steel pipe, leaving a vertical threaded inlet: a 107.5° bend to commence the upwards gradient of the serpentine.

**!! Note:** ensure this vertical run is at right-angles with the horizontal bisection of each bend, so that the inlet hole to the frame can be made accurately.

The serpentine will run upwards, 17.5° from horizontal. This will require seven 215° bends (inner diameter 10cm.) The first 215° turn comes approximately 20 cm from the end of the tube. There-after there is approximately 56cm between bends. One last 107.5° bend is made 20cm from the end of the pipe to leave a threaded vertical outlet. Again, care is necessary to ensure it is vertical to enable the frame to be accurately cut and drilled.

### **2.1.2 Joining the serpentine to the absorber plate with wire**

Instructions in Deus et al. (2004) are given for joining the pipe to the absorber plate with rivets or by welding. These methods would improve heat transfer, although attachment with wire is the easiest.

Tin snips are effective to cut the plate to size: 915mm x 1225mm. Cutting with an angle grinder should not be necessary and accuracy is difficult for sheet metal. The serpentine is placed on top of the sheet to mark its fixing positions: the mid-point of each 17.5° run, and of each bend. These points in the sheet are drilled with a 1mm hole either side of the pipes. Gal or stainless steel wire (to prevent rust) is threaded through from above, holding the serpentine in place (join by twisting on the underside.)



**Absorber pipe fixed to backing plate with gal. wire**

The absorber is painted with black anti corrosive matte paint. Painting before assembly may allow better access to tight crannies, but wastes spray paint. See *Design Manual: DIY Serpentine Solar Water Heating*, Section 9.1 on Selective Absorber coating. Painting the underside of the absorber plate will help protect against rust but is not essential. Ensure paintwork is not scratched by subsequent rough treatment.

## 2.2 The Frame

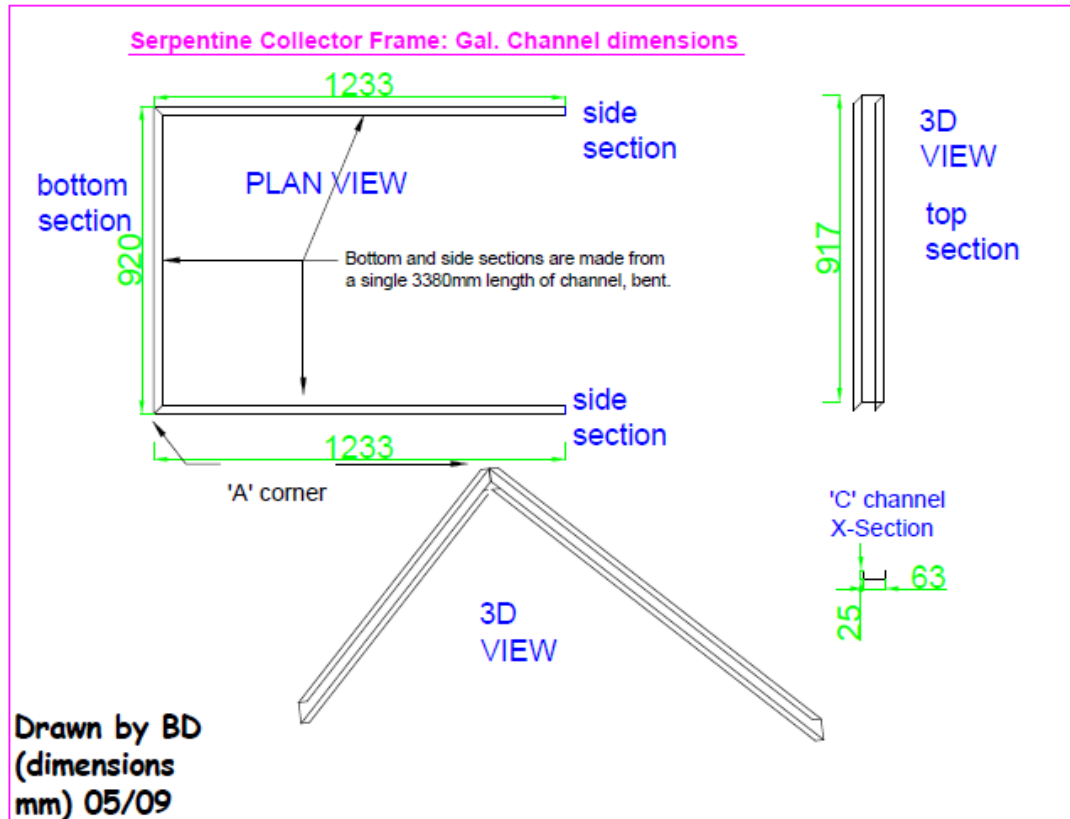

The absorber size determines the dimensions of the frame.

### 2.2.1 Side Sections

Use tip snips to cut the channel into a 917mm section and a 3400mm section. The 3400mm section will form the sides and bottom of the frame; it will be bent at approximately 1233mm and 2153mm, forming 1233mm → 920mm → 1233mm sections.

Drilling the inlet pipe hole in the 920mm section is instrumental for ensuring that the frame is square. Therefore the procedure for making the side sections is as follows:

1. Provisionally mark the points for cutting and bending: 1238mm and 2158mm. This allows an error margin for the 1233mm → 920mm → 1233mm sections.
2. On the 920mm section mark the position of the inlet hole for the pipe. If the pipe inlet is not at right-angles to the frame, this inlet hole will need to be too wide, causing heat loss. If necessary bend the pipe (with care) so that the inlet is vertical.
3. Drill the inlet using a 22mm hole saw bit. File the hole so that it will fit over the pipe easily without causing significant heat loss.
4. With the inside of the channel flush with the absorber plate remark the 920mm bottom section. The cutting / bending points marked by this section should leave at

- least 1233mm of channel on either side.
5. The 25mm sections are cut at these points using tin snips
  6. The wider side of the channel is bent inwards at right angles to form the sides and bottom of the frame.

**!! Note:** ensure that the sides and bottom sections of the frame are perfectly square.



**Frame Fabrication**

The (25mm) horizontal 'lips' of the side and bottom sections will overlap; those of the bottom section should sit on the inside of the frame. Line the inside of the channel with 63mm wide strips of *Termo-flex* insulation.



**Frame Side and Bottom sections: a complete length of channel**

### **2.2.2 Frame Backing Plate**

Use tin snips to cut to size: 915mm x 1228mm. Line with 920 x 1230mm sheet of *Termo-flex* insulation (2mm thick.) Paint the underside of the backing plate with anti-corrosive paint. Painting the inside is optional.

### **2.2.3 Frame Assembly**

1. Position the insulated backing plate inside the channel. Rivet in place.
2. Cut three 870mm lengths of channel. These will form spacers
3. Position the separators width-ways inside the backing plate at 300mm intervals. The 63mm section of the 'C' will make contact with the backing plate/ insulation.
4. Rivet the backing plate to the spacers.



**Collector frame mounted to insulated backing frame with spacers**

### **2.2.4 Top of the frame.**

Cut a 917mm section of Channel. Drill the outlet for the pipe as described in 2.2.1.

### **2.2.5 Enclosing the Absorber in the Frame**

Note: the absorber backing plate is drilled and the underside brackets are bolted to it from the inside. **This should be done before the absorber is enclosed in its frame.**

Slide the absorber into position inside the frame, sitting on the spacers. Slide the frame top over the serpentine outlet and rivet into place.

### Coating with absorbent paint



Once assembled in its frame, the absorber is re-painted with black anti corrosive matte paint. Paint the frame to prevent reflectance from the metal.

### **2.3 Mounting Brackets/ Clamps: Fabrication**

The underside brackets are made and bolted to the inside of the absorber backing plate before the absorber is enclosed in its frame. They could be attached to the finished collector however, using rivets or self-tapping strews.

#### **All of the following brackets must be made twice: one for each side**

Paint all the angle iron and flat iron to be used with anti-corrosive paint before assembly. Creating the brackets requires a high level of precision; they must fit together snugly to minimize danger of the glass falling out during high winds. The dimensions below are given as guidance. If collector dimensions are modified the brackets should be redesigned. It seems better to drill the collector upper-side brackets first and position the holes in the under-side brackets accordingly.

#### **2.3.1 Top of collector underside bracket:**

**Cut** a 195mm length of 25 x 25 x 2mm angle iron. This can be done with a hacksaw; if using a chop-saw allow for the thickness of the disc. Position the saw at 45° across one side, making an angled cut, and carry on sawing straight down with an angled saw on the other. Cut a second 210mm length at – 45°.

These two lengths now join together to form a right-angle. **Weld** together into a right-angle formation. The 45° weld identifies the horizontal side. **Drill** a 6.5mm ø hole 10mm from the edge on the longer (210mm) section (horizontal side.) In the shorter (195mm) section drill (6.5mm) holes, 50mm and 120mm from the edge (horizontal side.) Drill a hole on the vertical side of this 195mm section, 100mm from the right-angle. The exact position will be determined by alignment with the hole in the upper-side bracket, when they are both in position with the collector in between.

Top of collector brackets



SSWH - Bracket: top of collector, under-side

Side View

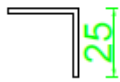

3D View

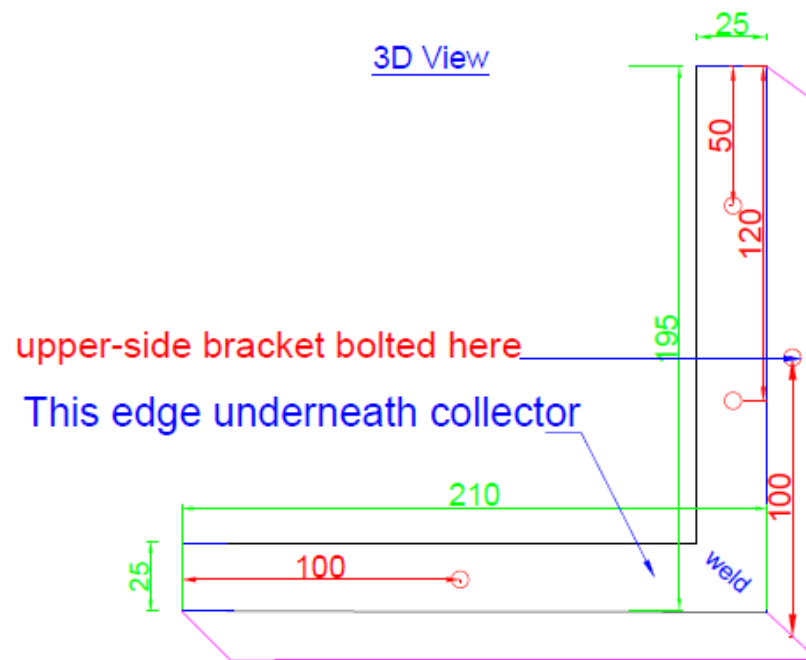

Drawn by BD  
(dimensions  
mm) 05/09

### 2.3.2 Top of collector upper-side bracket:

**Cut** a 120mm length of 25 x 25mm x 2mm angle iron. Cut 80mm of 20 x 2mm flat iron. Position the angled length so the vertical side faces downwards.

**Weld** the flat piece to the outside of the vertical side of the angle iron, 50mm away from its edge.

**Drill** a 6.5mm hole in the flat iron, near the end: approximately 12.5mm away.

Note: when the collector is mounted, sandwich rubber gasket strip between the upper-side bracket and glass for protection.

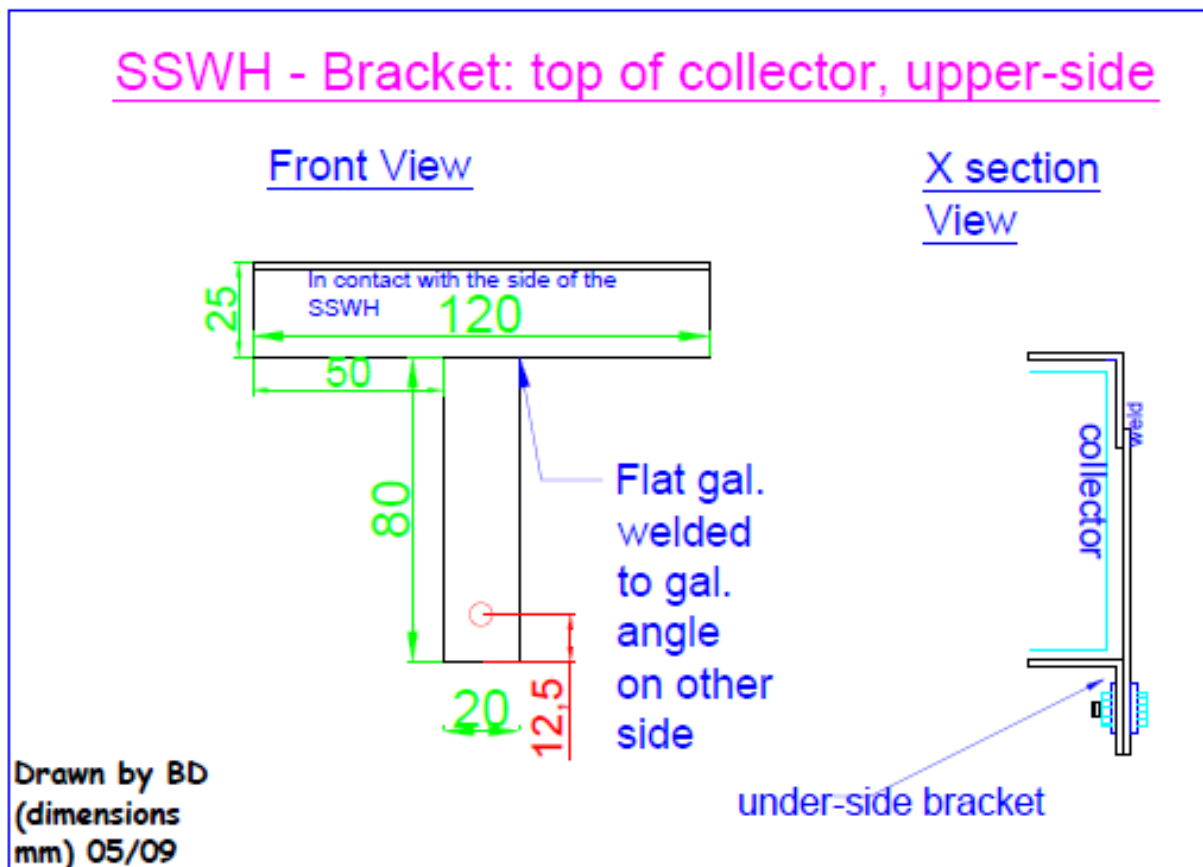

### 2.3.3 Bottom of collector upper-side bracket:

**Cut** a 190mm length of 25 x 25mm x 2mm angle iron. Cut 73mm of 20 x 2mm flat iron. Position the angled length so the vertical side faces downwards. **Weld** the flat piece to the outside of the vertical side, 79mm from right edge.

**Drill** a 6.5mm hole in the flat iron approximately 12.5mm from the end.

Note: when the collector is mounted sandwich rubber gasket strip between the upper-side



bracket and glass for protection.

### 2.3.4 Bottom of collector underside bracket:

**Cut** two 200mm lengths of 20 x 25mm x 2mm angle iron. This can be done with a hacksaw; if using a chop-saw allow for the thickness of the disc. Cut the first with the saw at 45°, making an angled cut on one side and a straight cut with an angled saw on the other. Cut the second 200mm length at - 45°.

These two lengths now join together to form a right-angle. **Weld** together into a right-angle formation. The 45° weld identifies the horizontal side. Position so that the vertical edge faces downwards. **Drill** a 6.5mm hole, 110mm from the weld on the right hand (200mm) section (vertical side.) The exact position will be determined by alignment with the connecting hole in the underside bracket, when they are both in position with the collector in between.

Cut a 94mm length of 25 x 25 x 2mm angle iron. Position vertically, with its angled edge continuing the line formed by the 90° welded joint (of the right-angle you have just made). The 2mm cross section is to be **welded** to the 2mm sides of this right-angle.

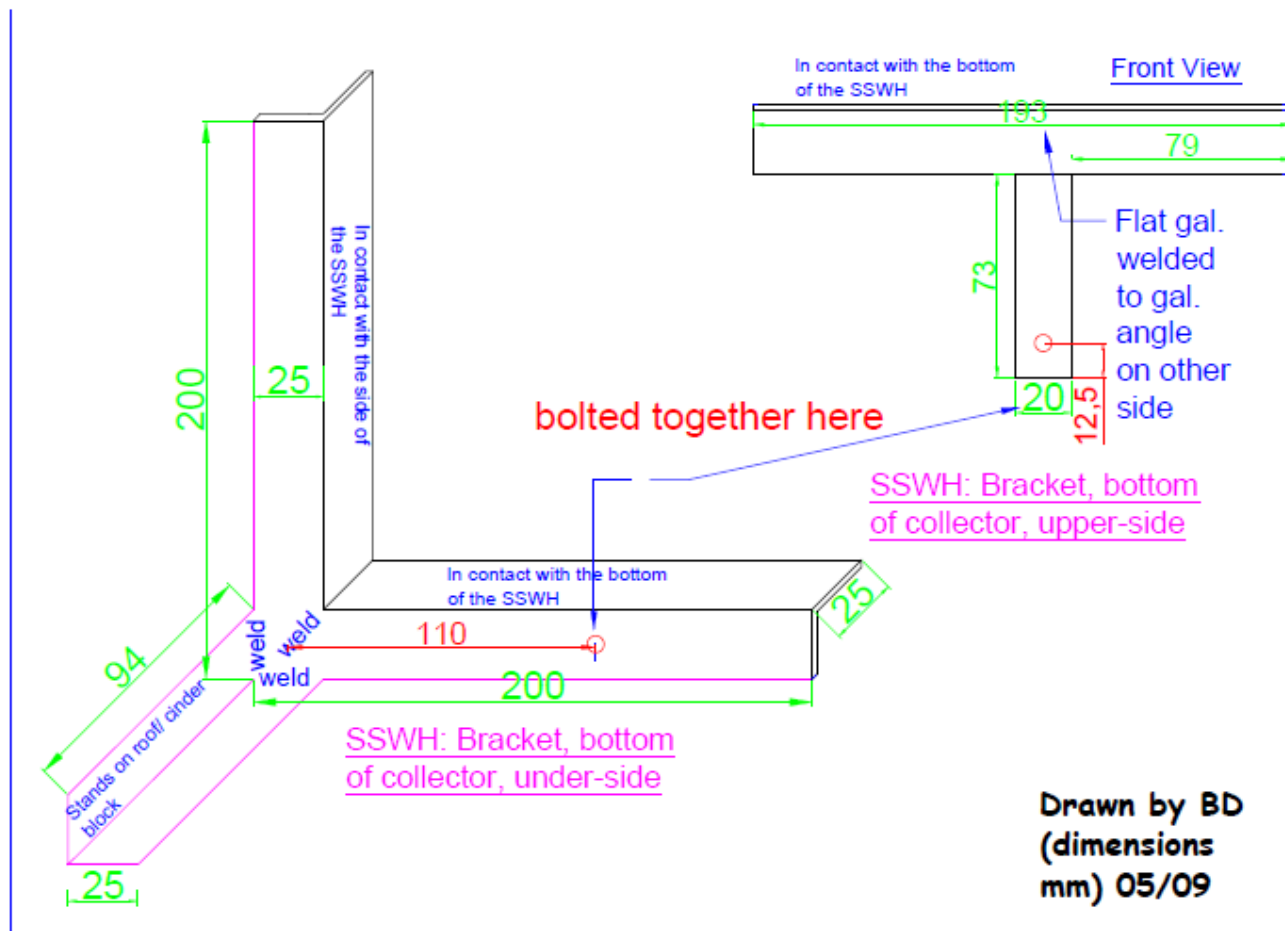

Bottom of Collector Brackets



### ***2.4 Mounting the Collector Cover and sealing.***

The glass cover sits on top of the collector frame and is held in place using the mounting brackets.

Rubber gasket strip lines the underside of the glass as an air tight sealant. Use of silicone for sealing makes it difficult to remove the glass without breakage. However air gaps between the collector frame and the glass are sometimes noticeable even with the gasket.

## 3 Fabricating the Hot Water Tank

### 3.1 Hot Water Tank Design

The tank is comprised of an inner barrel with an outer protective casing:

- 55 gallon metal drum casing (890 high x 580mm diameter) with lid.
- 35 gallon plastic barrel tank (780 high x 500mm diameter) with lid.

#### 3.1.1 Insulation

Two rolls of 2mm fiberglass *Termo-flex* insulation (approx 1800 wide x 900mm high each) are wrapped around the inner-tank and one inside the outer drum. A cylindrical piece of polystyrene foam is used to cover the inner tank lid for extra insulation: approximately 25mm thick x 56mm diameter.

#### 3.1.2 Inner tank hole positions for inlets<sup>1</sup>

(bottom of the tank's inside to hole centre)

- Cold water feed – 100mm
- Hot water out – 540mm
- Solar Flow (hot) – 460mm
- Solar Return (below it) - 95mm.

#### 3.1.3 Outer tank hole positions for inlets

(from floor outside the tank to hole centre)

- Cold water feed – 130mm
- Hot water out – 570mm
- Solar Flow (hot) – 490mm
- Solar Return (below it) - 125mm

**!!** Note: these positions are approximate. They are based on the Inner tank inlet positions. The exact outer tank hole positions will vary, according to the tank height difference; based on the tank thickness, insulation and the off-cuts positioned between the two.

Alignment between the two tanks is easier to achieve by drilling the outer-tank first, although this method may vary inner-tank hole positions.

Plumbing to the tanks is carried out with ½” fittings. The holes for these inlets should be made 0.5mm larger than the fittings. Holes made in the inner tank for inlets must be sealed to prevent leaks. The outer tank forms a protective casing; inlets should be sealed to prevent ingress of rain-water (leading to rust on the inside of the drum.)

---

<sup>1</sup> Note: These positions are thought to be optimal for the inlets but they are yet to be tested.

Inlet heights correspond to hot water stratification in the tank. The best position for the solar flow and return inlets around the perimeter has not been investigated. However, if they are on the opposite side from the cold and hot to and from the house, this may simplify plumbing.

### **3.1.4 Fittings Required for Inlet Plumbing**

The tank inlets are sealed with 'bulkhead' fittings. From inside of the inner tank:

Coupler → nipple (this passes through the inner tank wall and its insulation), → coupler, → long nipple (this passes through the outer tank wall and its insulation)

**If** this nipple is long enough → Gal. to CPVC adaptor → CPVC pipe

**Otherwise** connect outside of the cylinder: Coupler → Nipple → Adaptor → pipe

The bulkhead fittings are made water tight with a rubber washer and then an HG washer on either side of the nipple penetrating the inner tank. HG Washers are supplied according to the size of the fitting, but should be wide enough for effective sealing. During tightening the HG washer should apply even pressure on the rubber washer. High-temperature-silicone is also applied on the inside. Threaded joints are to be sealed with PTFE (Teflon, preferably the high temperature resistant variety.)



**Inner hot water tank: bulkhead fitting (outside the tank)**



**Inner hot water tank bulkhead fitting (inside the tank)**

### **3.1.5 Cold Water Inlet: float valve and shut-off valve**

The cold supply should have a shut-off valve on the outside of the tank. It also features a float valve inside the cylinder, to shut off the supply when the tank is full (like a toilet cistern.) Supplied with male threading, its connection substitutes for the nipple which passes through the inner tank wall in the list above. It is usually supplied with an HG washer; an extra rubber washer is fitted on the inside of the tank, and a rubber and an HG washer on the outside.

It comes supplied with the float connected to an attachment 'arm'. If the arm is too long for the tank, it can be replaced by an 8mm screw. The inlet is low down, to prevent mixing with the hot water higher up, so the float is cut from the arm and reconnected with a small link chain, (approximately 450mm for the valve to close when the tank is full: 20mm below the top of the tank). A sacrificial anode would prevent corrosion caused by dissimilar metals (e.g. the chain).

The cold water inlet is plumbed to the outer tank as follows:  
(Nipple from the inner tank) → shut off valve → nipple → adaptor → pipe

### **3.1.6 Weather proofing**

The outer drum should be painted black with anti-corrosive paint before assembling the inlets. Each hole in the outer drum should be protected against rain ingress with a 76 x 76mm patch of black rubber. A small piercing is made in this material and the pipe passed through with a snug fit. The patch is attached around the hole in the tank with silicone on the sides and top; leaving the bottom unsealed allows any water ingress behind the patch to escape. The outer tank's underside should be drilled with several holes to allow drainage in case of rain ingress.

## **3.2 Hot Water Tank Fabrication**

### **3.2.1 Making the holes in the inner and outer tanks**

- 1) Mark the holes in the outer drum. This should aim to correspond with the positions of the holes in the inner tank. Allow a height difference (between inner-tank inside and outer tank outside) based on the inner tank thickness, and the insulation and wooden off-cuts you will position between the two.
- 2) Drill the outer drum using a hole saw for metal. These should be just large enough for a coupler (female) fitting to pass through. Remove burrs with a file.
- 3) Place the inner tank inside the drum to mark the inner holes.
- 4) Drill the Inner tank holes. 'Spade' drill bits for wood can be used. Start small and gradually increase the hole until the nipple (usually ½") fits snugly (aim for Ø of hole 0.5mm larger than the fitting.)

### **3.2.2 Assembling the Inlets**

1. Assemble the inner tank bulk head fittings (nipple, washers, and couplers on each side of the tank wall.) The fittings shown in the photo below are easier to tighten in a vice before mounting on the tank itself.
2. Apply high temperature resistant silicone to the inside of the tank wall for sealing. Wait for this to dry.
3. Attach end-stops to the outside couplers. Fill up the tank for a leak test.
4. Line the bottom of the outer drum with (level!) wooden off-cuts, increasing insulation.
5. Wrap two sheets of *Termo-flex* insulation around the tank and one inside of the drum. Position the tank inside the outer drum.
6. Fit the long nipples that pass through to the outside of the metal drum.



**Bulkhead fitting assembly**

### **3.2.3 Creating the rubber washers**

The rubber washers can be made in the workshop using tough rubber.



**Making rubber washers**

## 4 Installation

### 4.1 Selecting the Site

#### 4.1.1 Azimuth. Angle of orientation, with respect to south ( $0^\circ$ )

This should be as close as possible to Due South ( $0^\circ$ ) in the Northern Hemisphere, or Due North ( $90^\circ$ ) in the Southern Hemisphere, for maximum solar irradiation. However, sometimes it's better to deviate from optimal azimuth to avoid shading.

#### 4.1.2 Inclination. Angle of pitch (for serpentine installation on the roof)

On a pitched roof, the angle of the collectors is usually fixed. However the serpentine system is more suited to flat roofs making it possible to choose collector inclination.

Optimal inclination to generate maximum solar gain is a function of latitude, but also of the use and performance of the solar system through the year. A steeper pitch angle will receive more solar energy in winter months; though **average** solar irradiation/ $\text{m}^2/\text{day}$  would be higher if inclination is the same as latitude. A solar pumping system for example would require inclination for maximum solar gain during summer (latitude – 20 to  $23^\circ$ ); to cope with peak demand for pumping.

For year-round household demand a solar serpentine system should be installed for maximum Winter solar irradiance. Following the advice of Jaume Domingo, a pioneering Catalan solar engineer, in Equador and tropical zones, with a similar irradiation through the year, its reasonable to match inclination to latitude. In Xela, Guatemala, a temperate zone with lower Winter irradiance, the inclination should be latitude + (20 to  $23^\circ$ )  $\rightarrow 35^\circ$ .

#### 4.1.3 Shading

##### **!!Select a shade free site for the solar collectors.**

The performance of the SSWH depends on maximum exposure to solar radiation. The solar array should not have tall buildings, trees or hills positioned in front of them (to the North in the S. Hemisphere or South in the N. Hemisphere). This is also true for protrusions from the roof. Even shading objects to the East or West can have an effect, as during the day the sun will move from East through Southeast (or Northeast in the Southern Hemisphere) through South then through Southwest to West.

#### 4.1.4 Position of the Solar Installation relative to the shower

Flow to the shower depends on the pressure drop from the hot water tank. In the pipe between the tank and the shower, straight vertical drops improve flow (although long runs should be insulated to prevent heat loss.) Minimise horizontal 'dead-legs' which will restrict flow.

## 4.2 Pipe-work

### 4.2.1 CPVC

CPVC is currently used for flow and return pipe-work between the solar panels and the tank and the hot water flow to the shower. Its pressure rating is 100 PSI @ 180° F (82° C); it should not be used for applications which exceed this temperature. In order to protect it from UV degradation on a sunny roof it should be painted with exterior grade latex paint. Joins should be sealed with CPVC solvent cement.

System installers in Guatemala report difficulty in connecting CPVC to fittings of other materials even though they have the same nominal diameter. A length of CPVC, galvanized, and PVC pipe which are all supplied as ½", for example, will have different actual diameters due to the allowance that is made for roughness. Make sure you leave the plumbing shop with the right reducers/ adaptors for these connections.

### 4.2.2 Copper: Protection against high-temperatures

The author worries about the ability of CPVC to withstand maximum collector outlet temperatures. See *Design Manual: DIY Serpentine Solar Water Heating*, Section 9.1 for discussion on copper pipe.

### 4.2.3 Pipe-work installation for thermo-siphon.

Circulation between the collector and the tank requires an upwards gradient in the pipe, if possible >45°. It is easier to achieve this gradient by keeping the pipe run as short as possible. The only requirement for proper functioning is that relatively larger piping be used since the pressure available to cause fluid to circulate is relatively small. 1/2" will do for typical installations, but where there are long pipe runs or more than three collectors, larger diameters may be necessary for good flow. Piping should have a minimum of tight elbows, and sweeping bends are preferred to reduce pressure drops.

All Connections should slope upwards (B. Deus et al, 2004)

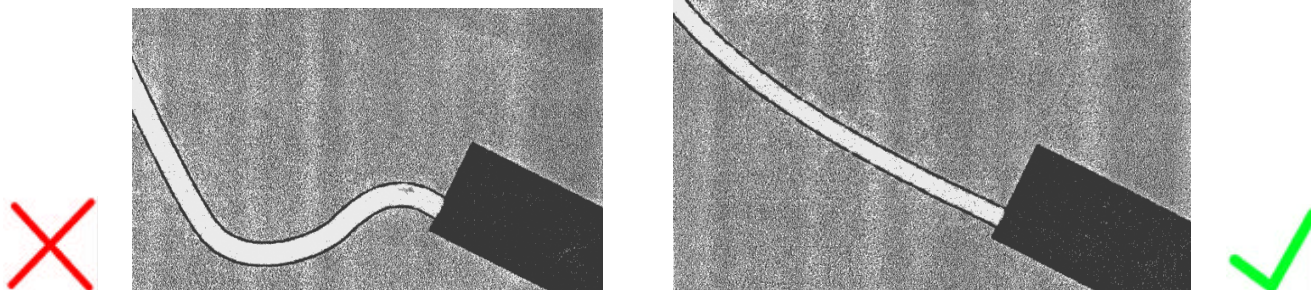

*Connection from collector (bottom right) running up to storage tank (top left). Because there is a dip in that connection an air bubble will block the circulation immediately and consequently the system stops functioning*

*This connection is sloping upwards and so there are no problems with the hot water circulation.*



#### **4.2.4 Pipe Lagging**

Evaluation is yet to be carried out on the improved system efficiency gained by insulating the solar circuit, compared with the extra cost. It has been assumed that losses from the plastic pipes are minimal due to the low thermal transfer of plastic. However side by side system temperature tests with insulated and un-insulated pipes would be recommendable. As shown in the case studies in the appendix, there needs to be a better system for installing pipe lagging (e.g. PVC glue)

#### **4.3 System Charging: procedure for air-venting**

'Charging' refers to filling the SSWH system with water. This procedure aims to purge air from the system and should be followed during installation and any repairs. The fitting used on the inlet to the hot water tank needs to be a movable coupler so that the pipe can stay fixed while it's being tightened ("union universal" in Spanish)

**Movable coupler**



1. Complete all the pipe-work but leave the final joint between the CPVC pipe and the inlet to the tank unconnected. Connect the cold return pipe between the tank and the collectors, but the hot feed pipe just to the collectors
2. Turn the valve on the cold feed to the tank to fill the tank with water. This will then go to the collectors
3. Let the water run out of the top of the feed pipe; this will purge the air
4. Now connect the (hot pipe) to the tank, by tightening movable coupler union (see photo.)
5. If there is still air in the system repeat the procedure.
6. The cold supply will automatically shut-off when the tank is full

#### **4.4 Thermal Mixing at the Shower**

In Europe solar thermal systems are fitted with an anti-scald valve, usually on the hot water outlet from the tank. This mixes with cold water to maintain a predetermined maximum temperature. In Guatemala, the hot water pipe from the tank should be connected into the existing cold water-fed shower pipe. There should be a cold water shut-off valve before the T, so that users can mix the water from the solar system if it is too hot. The use of each valve should be made clear to users with an explanatory poster.

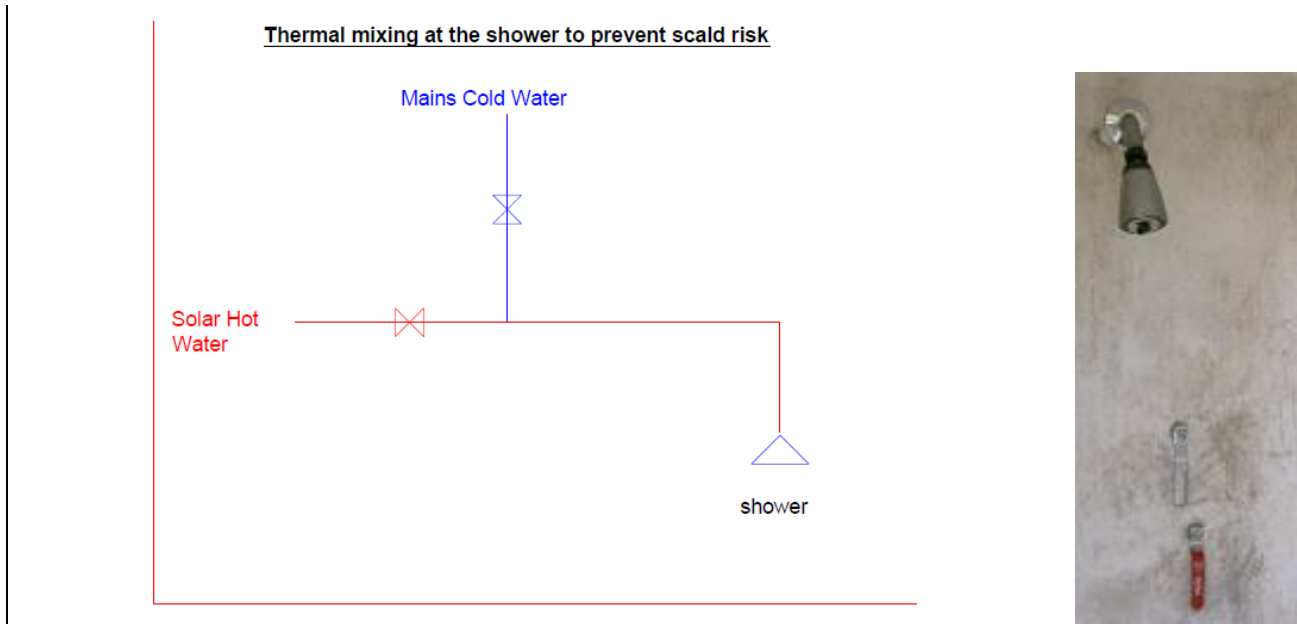

#### 4.5 Mounting Systems

In the existing AIDG/ Xelateco installations the collector support structure usually consists of propping up the top of the panel with two breeze blocks on each side. Tanks are also supported by a base of blocks, only higher. In other countries with stringent building regulations, solar installations on flat roofs have demanding requirements on ballast weight to counteract maximum wind loads. Mounting structures on pitched and flat roofs add considerable design and labour time to an installation not to mention cost. It wouldn't be possible to copy these over-engineered models. However some improvements would be worthwhile to make the systems more robust against storms.

One addition, included at Nueva Alianza (A2.1), would be angle iron 'A-frames' for the collectors. This consists of (on each side) a horizontal strut connected to the bottom corner, bolted to a vertical strut which is connected to the top corner. The vertical and horizontal lengths should be calculated for optimal collector inclination (35°.) They should be bolted to the collector brackets and strengthened with angle iron connections between the vertical strut on each side. An 'A-frame' structure at Nueva Alianza is shown in photo MS1.

These A-frames underneath the collector should be bolted to concrete blocks or the roof itself if possible. This provides anchor weight against winds. If blocks are used they should be cemented when their final position is set. The height and shape of the tank increases its vulnerability. Its breeze block base needs to be cemented, and brackets should be designed to hold it in place.

MS1 A-frame solar panel support structures (Nueva Alianza)



The mounting system dilemma in Guatemala can be seen in the installation at La Guarderia. One of the three collectors is just supported against a wooden beam, and the wires used to hold it all in place would be like a band-aid in a hurricane. However, these methods reflect construction generally in Guatemala. The size and type of roof wouldn't have allowed a very different mounting system, and it has supported a working system for three years.

MS3 La Guarderia: a bit of wire and a prayer.



MS4 Guatemalan roof mounting at La Guarderia



## 5. Material Costs in Guatemala

Each installation for 3-4 people takes 3 panels and 1 tank. **Total cost: 3359 Q (\$420.)** This included pipes and installation accessories, but not installation labour or overhead.

### Materials: 1 Serpentine Solar Collector

Item	Quantity	Individual cost	Total cost
Galv. channel, 25mm x 63mm x 25mm	4.3m (2 10' lengths required)	26.60Q per 10ft length	53.2Q
Rubber gasket, width?	4.3m		30Q?
½" Gal pipe	6m	120Q/ 6m	120Q
Rivets, 5/32" x 1/4	50		3.25Q
Termoflex insulation	3m	25Q	75
Gal iron plate, cal 28: absorber	(3' x 4')	(70Q - entire 3' x 8' sheet)	35Q
Gal iron plate, cal 26: backing plate	(3' x 4')	(104Q - entire 3' x 8' sheet)	52Q
Transparent glass pane 5mm x 36" x 48"	1	110Q	110Q
Anti-corrosive black paint	1/10 gallon	15.2Q	15.2Q
Gal flat iron	0.5m	15Q/ m	8Q
Angle iron, 2.04m	2m	15Q/m	30Q
Gal wire for absorber assembly			20Q?
Labour fro manufacture, 6 hours	6hours	18.75/ hourQ	112.5Q
<b>Total</b>		<b>664.15Q (\$83)</b>	

### Materials: Hot Water Tank

Item	Quantity	Individual cost	Total cost
18" x 32" blue plastic barrel + lid	1	150Q	150Q
Float Valve: ½"	1	52Q	52Q
Float Valve: Chain	1	?	20?
Float Valve: 8mm screw (replace attachment arm)	1	10Q	10Q
Sacrificial anode	1	?	30?Q
55 gallon drum + lid	1	160Q	160Q
Termoflex insulation, 6.2m	2	25Q/m	150?Q
Shut off Valve, 3/4"	1	41Q	41Q
Nipple, ½" HG x 2" long	5	5.25Q	26.25Q
Nipple, ½" – 4" long	4	6Q	24Q
Coupler, ½ " HG	7	3Q	2Q
Washer, 1/2", HG	7	3Q	21Q
	enough for 8 washers	?	20?Q
Rubber to make rubber washers	washers		
Female adaptors: 1/2" CPVC→ ½" HG	9	10Q	90Q
	enough for 4 seals	?	5?Q
Rubber for outer tank seals	seals		
Anti-corrosive black paint	1/10 gallon	15.2Q	15Q
Labour for manufacture, 8 hours	8 hours	18.75Q / hour	150Q
<b>Total</b>		<b>966.45Q (\$120.80)</b>	

400Q is estimated for pipes and accessories needed for installation (assumed to be CPVC.)

## Appendix 1 Constructing the Pipe Bending Set

Reprinted from B. Deus et al (2004) : *ZigZag Collector*, BABICO and WOT Publications

The pipe-bending set consists of 2 parts:

- a wooden frame fixed to an existing bench
- an iron bending set, to be fixed to the wooden frame

The wooden frame -composed of different blocks- is needed to support the bending set. It also provides the horizontal zigzag-shape of the pipe. The wooden frame has to be made of strong timber.

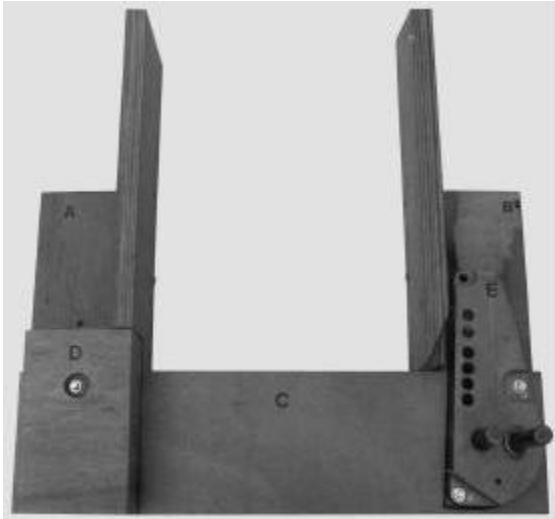

*The wooden frame is necessary to support the  
Iron parts of the pipe bending set  
It also provides the horizontal zigzag shape of the pipe*

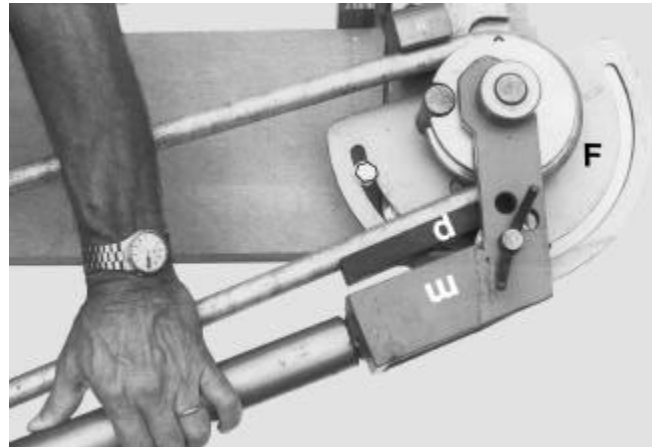

*The pipe bending set consist of interacting iron parts*

### Constructing the wooden frame for the pipe-bending set

The following **tools** are needed:

- ; a big hand saw or sawing machine; a carpenters square; a folding ruler; a marker; a hammer; a plane; a chisel
- ; a drill (4-6-8 mm.); a screw-driver

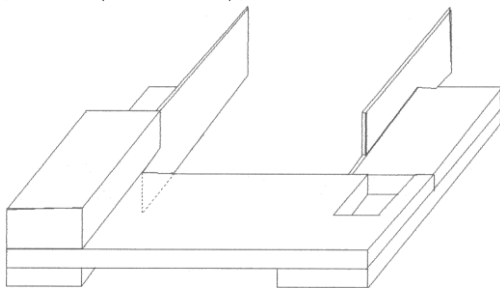

The following **materials** are needed:

- sturdy timber; screws (thickness at least 6 mm.); bolts and nuts

Saw 2 blocks - length 50 cm, width 16 cm; thickness 4 cm. Mark the 2 blocks with A and B.

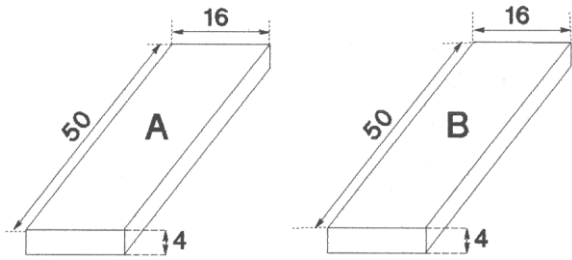

Saw 1 block - length 75 cm; width 16 cm; thickness 4 cm Cut out at 4 cm. from the end of one long side a rectangular space of 8 cm. by 8 cm. (see picture). Mark the block with C.

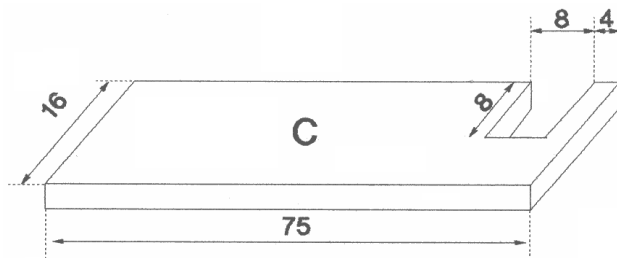

Saw 1 block - length 34 cm, width 16 cm; thickness 4 cm. Mark the block with B-2.

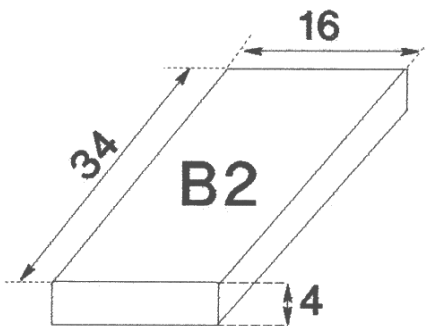

Join the block A, B, and C together as shown in picture below. Then fasten block B2 onto block B.

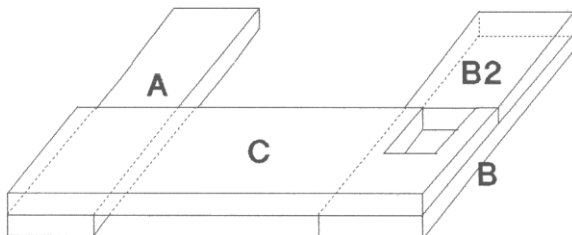

Saw 1 block - length 25 cm; width 18,5 cm; thickness 8 cm Mark block with D

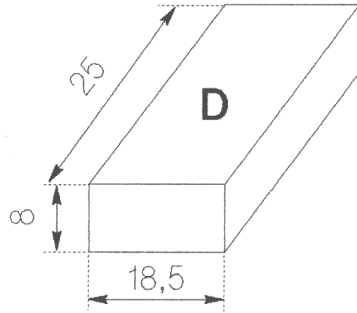

Fasten block D onto block C as shown in picture below.

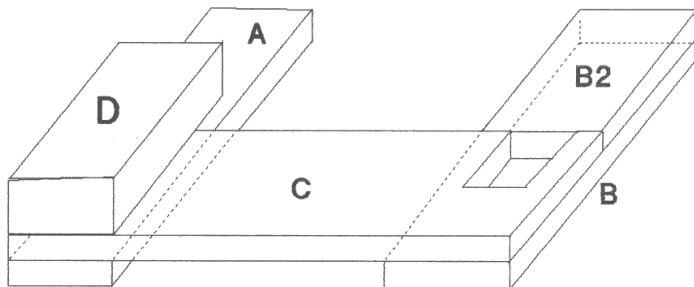

Saw 2 planks - length 60 cm; width 16 cm; thickness 2,5 cm

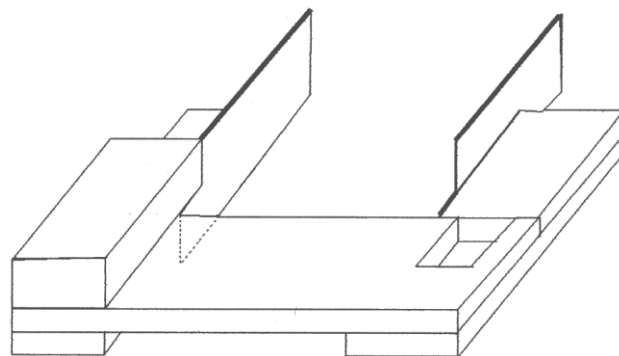
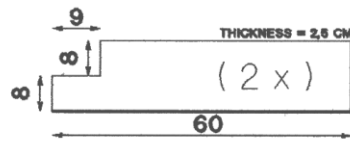

Cut out at one end of the long side a rectangular space of 8 cm. from the top and 9 cm from the middle. Put both planks against block A and B. Both planks must touch block C. Block D fits into the space. Now fasten the planks to block A and B. The wooden frame is complete.

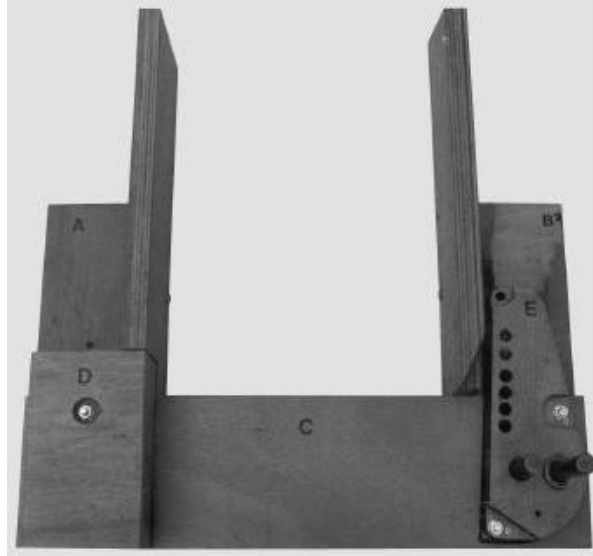

### Preparing the pipe-bending set

The following **tools** are needed: a drill-brace and drills; some spanners (ring spanner nr. 17); a screw-driver; some adjustable wrenches

Put the wooden frame on an existing bench. The bench must be a very stable one because of the forceful power needed to bend the pipes. Ensure that there is a free space with a radius of at least 3 metres around point X of the wooden frame. (see picture below)

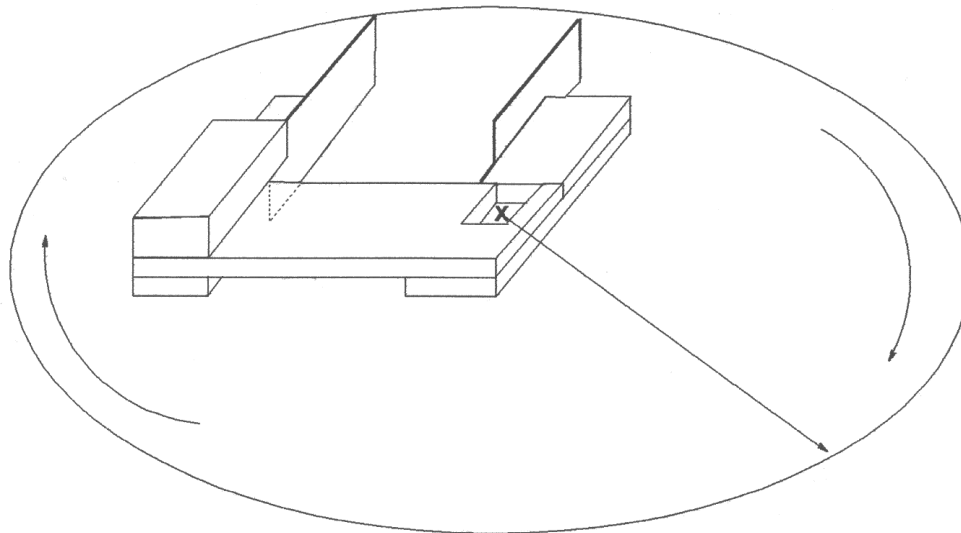

*Pay attention that there is a free space with a radius of at least 3 metres around point X of the wooden frame.*

Put groundplate E on the indicated place of the wooden frame. The big nut at the bottom of E fits into the rectangular space in block C. Drill 2 holes through E, and 1 hole through block D (see black arrows). The drilled holes also perforate blocks C, B and A. By means of fixing bolts, groundplate E and block D are tightly fastened to the frame. (keep the bolts on top (see photo))



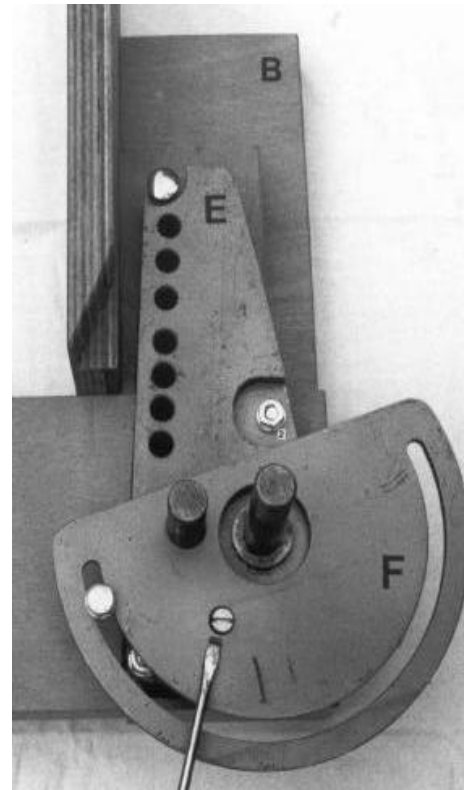
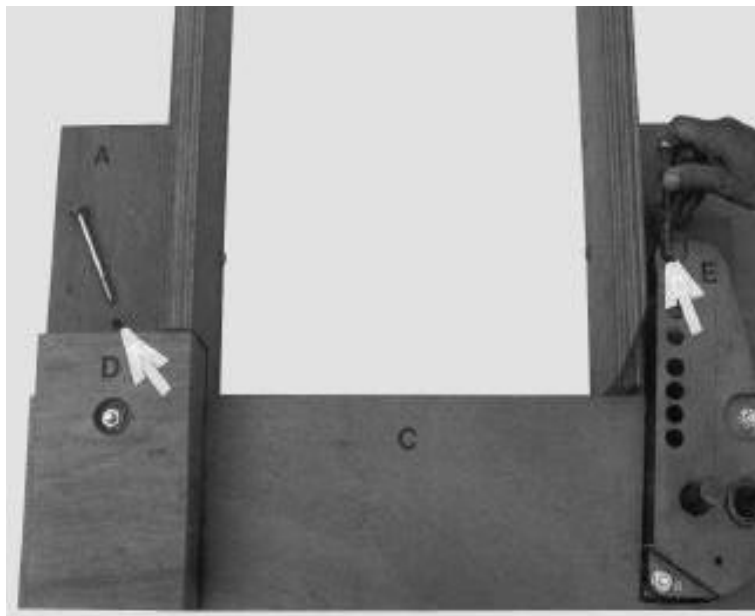
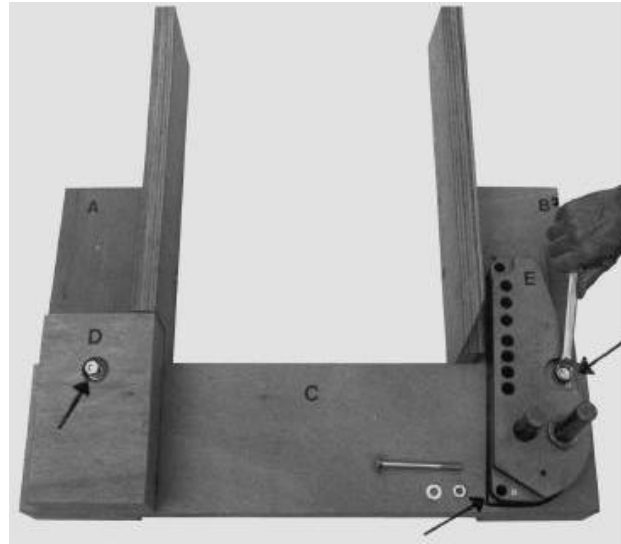

*Drill 2 holes through block A and groundplate E (see white arrows). The drilled holes must also perforate the bench. By means of big Fixing bolts the wooden frame is fastened to the bench. If necessary use some extra fixing bolts to secure the connection between frame and bench. The connection must be as firm as a rock.*

*Fasten the bending plate F onto the groundplate E by means of a screwdriver*

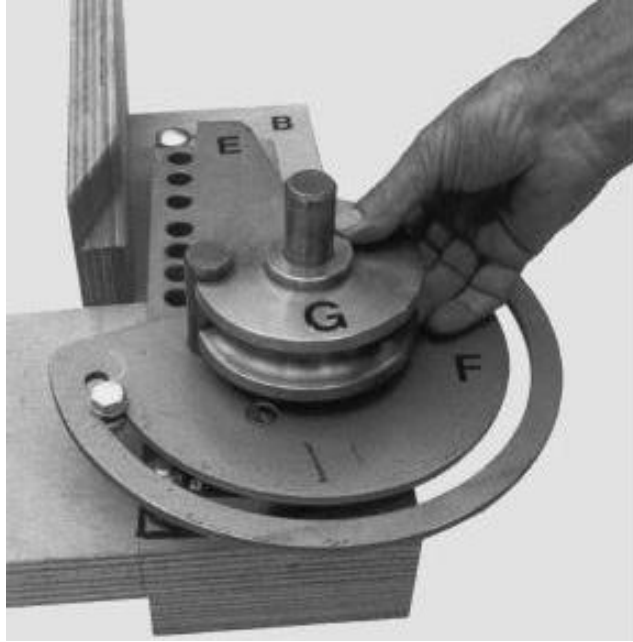

*Slip the bending disk G over the long spindle.*

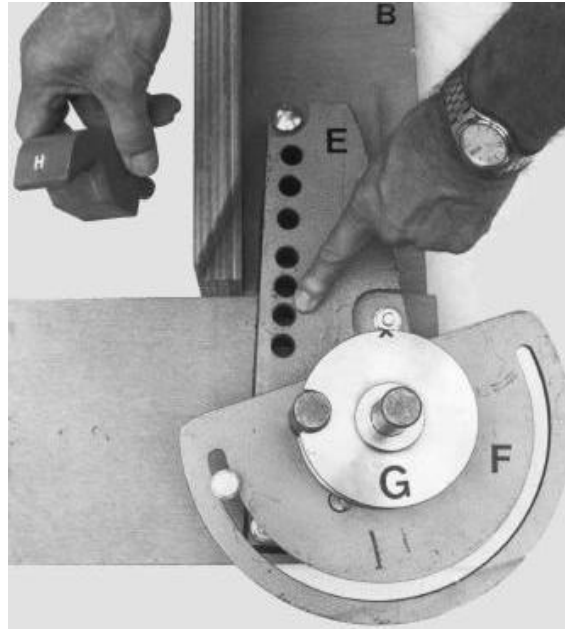

*Stick the clamping-block H into the second hole of groundplate E.*

## Appendix 2: Alternative Bending Set with dimensions

The bending set described by B. Deus et al (2004) and in Appendix 1 does not include dimensions. AIDG Guatemala has a different set, although at the time of writing modifications are still possible. Dimensions are included in the drawings below.

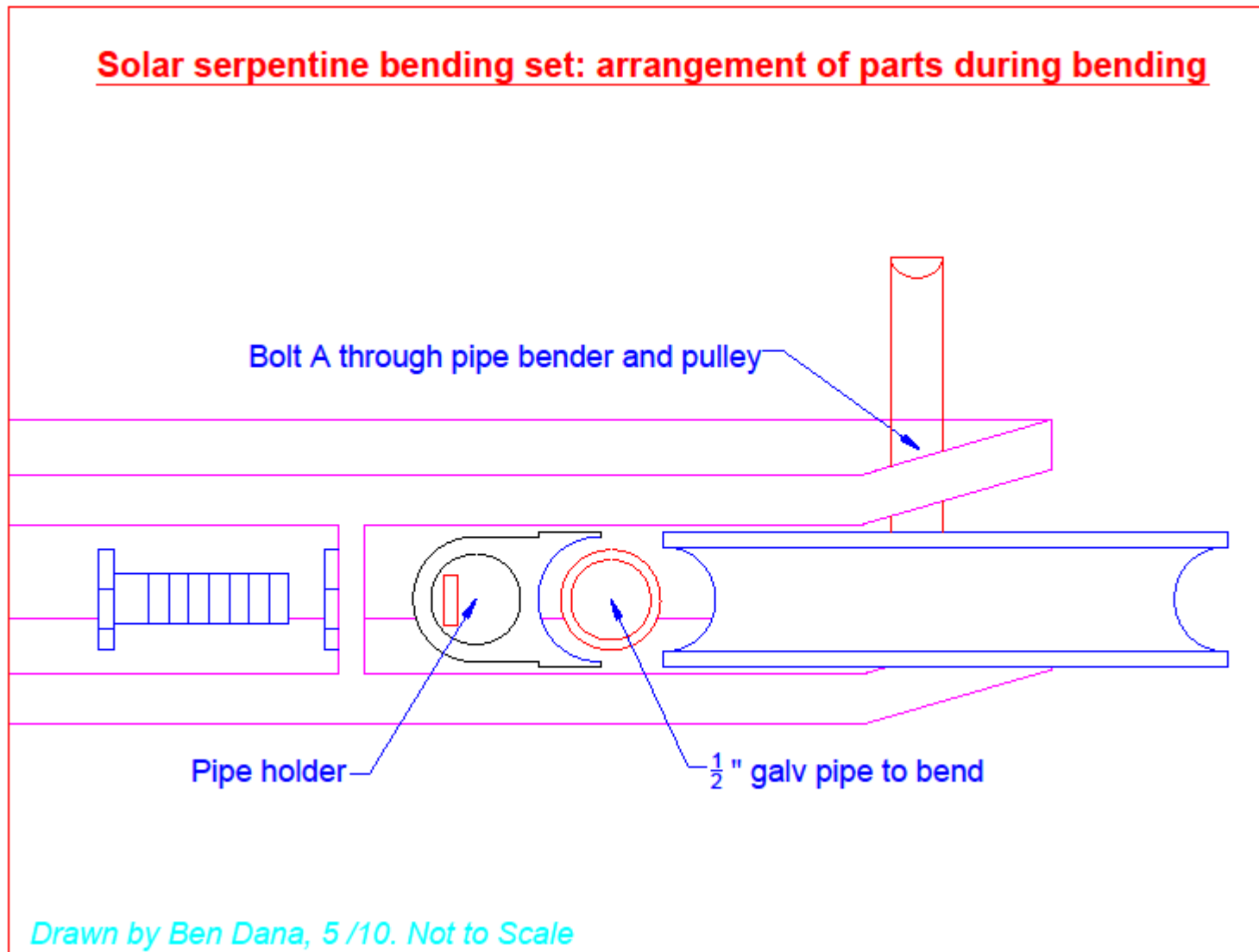

### Solar Serpentine Bending Set: Pipe Bender

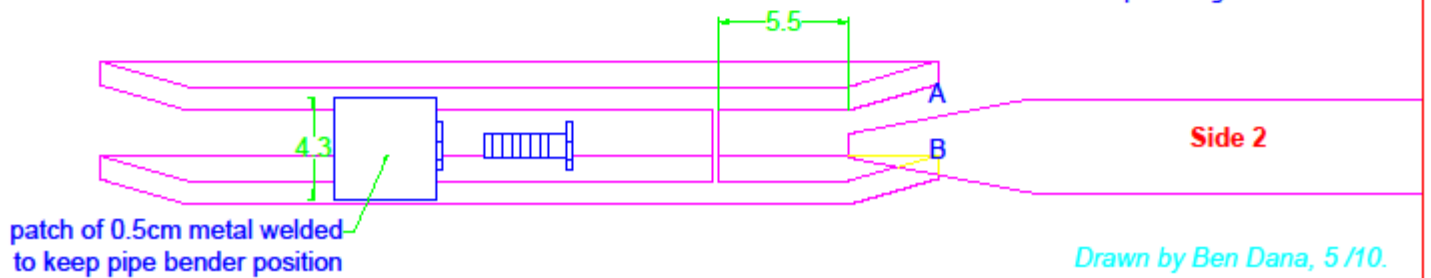
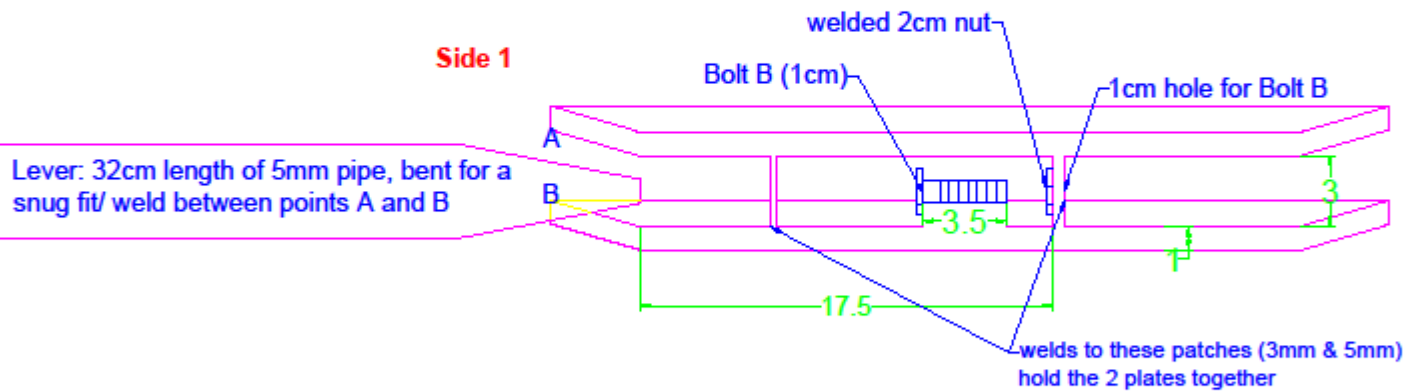
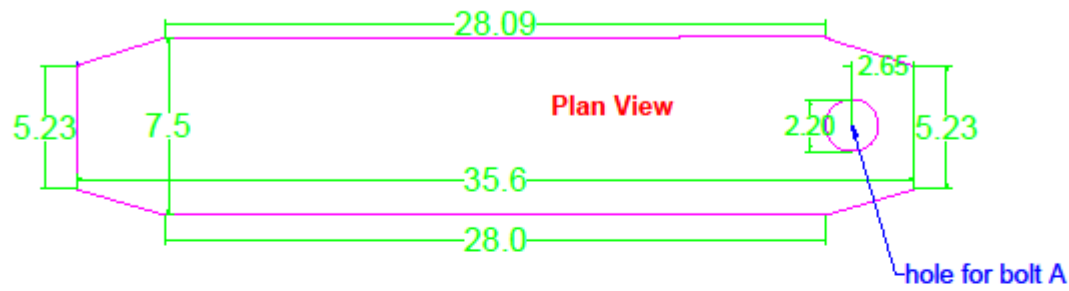

Drawn by Ben Dana, 5 /10.  
Dimensions cm unless shown

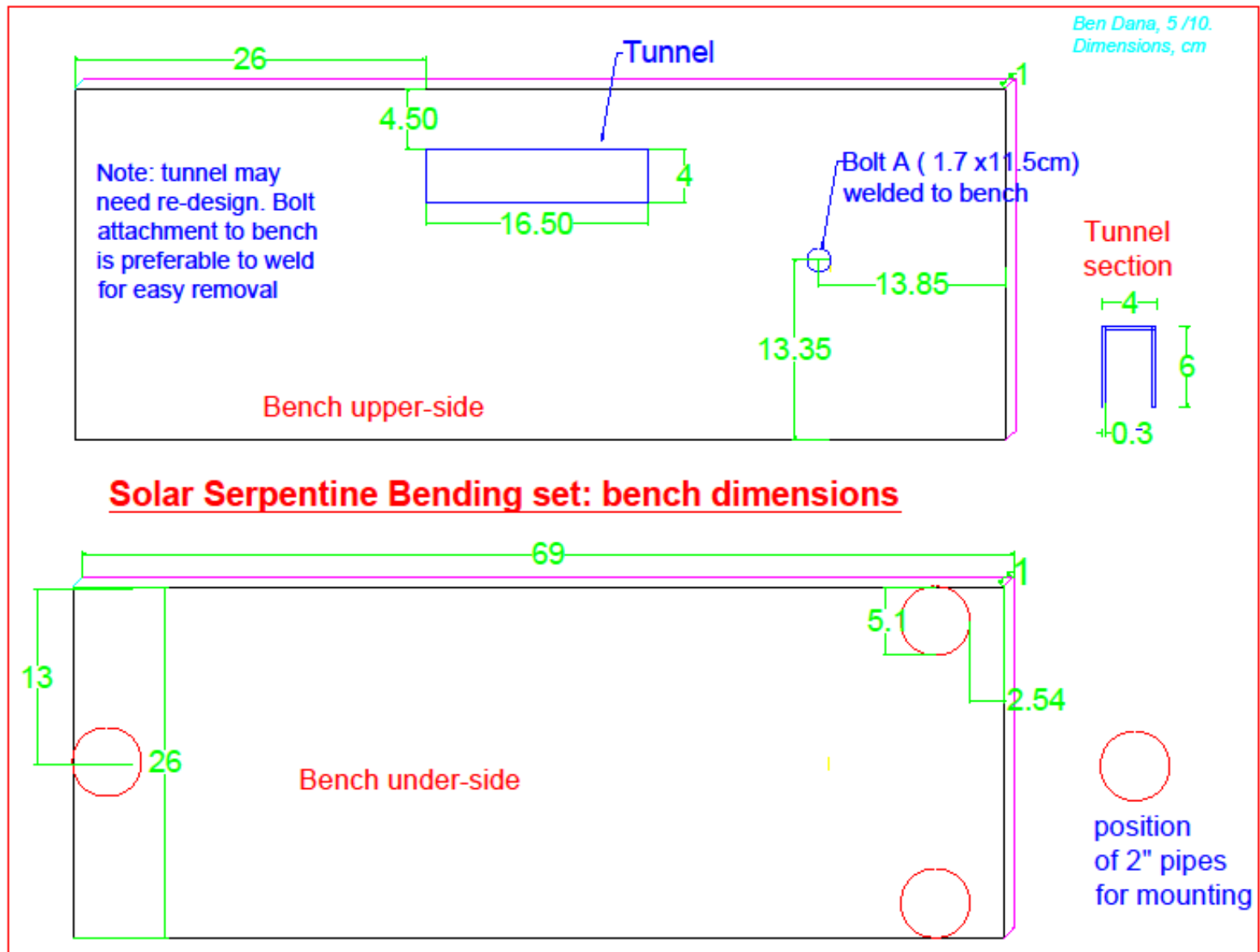

By Ben Dana, 5/10.  
Dimensions cm

### Solar Serpentine Bending Set: Pulley and Pipe Holder

Pipe holder: section

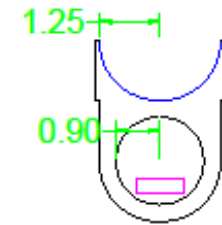
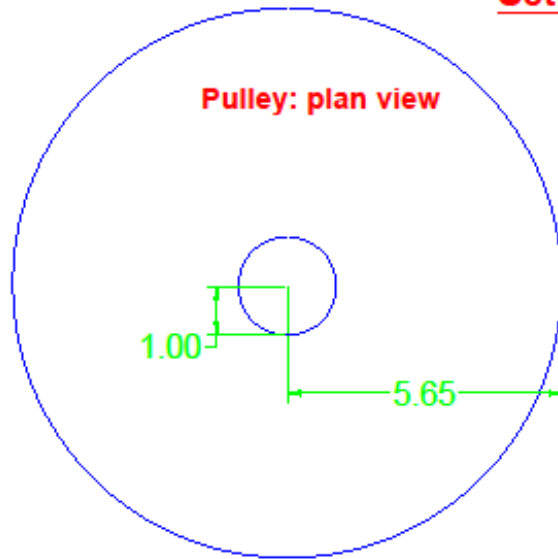

P. holder: side view

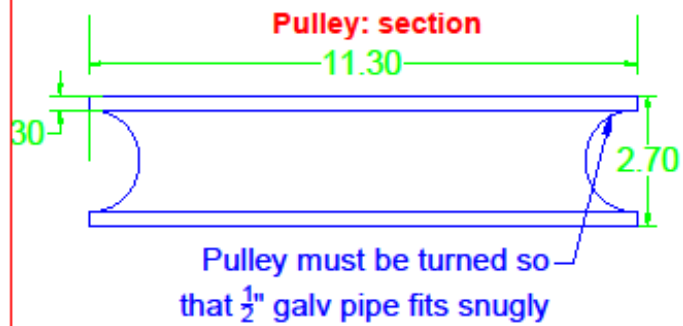
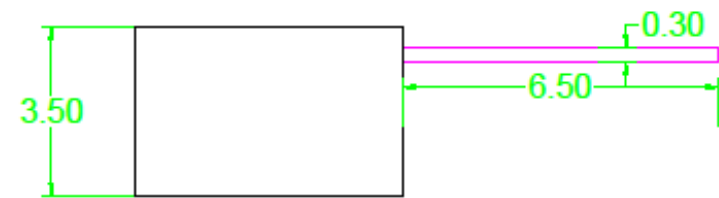

P. holder: plan view

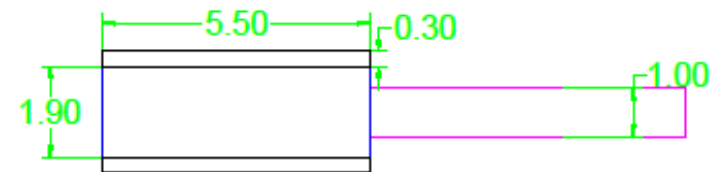

The photos below represent the pipe bender shown in this appendix, even though it's dimensions are different.

